

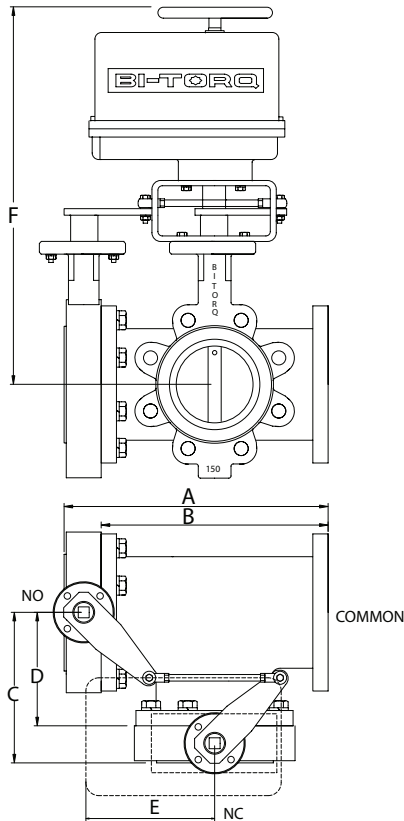

BUTTERFLY VALVE TEE LINKAGE ASSEMBLIES: ARRANGEMENT #4



**ALL AVK CARBO-BOND/
BI-TORQ THREE-WAY TEE
LINKAGES CONSIST OF:**

- 2) LUG STYLE BUTTERFLY VALVES WITH EPDM, BUNA-N AND VITON SEAT OPTIONS
- 125# CAST IRON TEE
- PNEUMATIC OR ELECTRIC ACTUATOR
- CUSTOM MOUNTING HARDWARE
- FULL ASSEMBLY AND TESTING
- 6 ARRANGEMENT OPTIONS

ELECTRIC WITH NEMA 4 ENCLOSURE

VALVE SIZE	A	B	C	D	E	F	ACTUATOR
2"	10.69	9.00	6.19	4.50	4.45	15.47	BI-300-A-4-P1
2.5"	11.81	10.00	6.81	5.00	4.62	18.84	BI-400-A-4-P1
3"	12.81	11.00	7.31	5.50	4.62	19.08	BI-675-A-4-P1*
4"	15.05	13.00	8.55	6.50	4.62	19.82	BI-1000-A-4-P1*
5"	17.20	15.00	9.70	7.50	4.62	20.34	BI-1500-A-4-P1*
6"	18.20	16.00	10.20	8.00	6.25	22.96	BI-3800-A-4-P1*
8"	20.36	18.00	11.36	9.00	6.25	24.30	BI-3800-A-4-P1*
10"	24.68	22.00	13.68	11.00	6.25	25.56	BI-3800-A-4-P1*
12"	27.07	24.00	15.07	12.00	13.00	26.77	BI-5000-A-4-P1*

*includes declutchable manual override

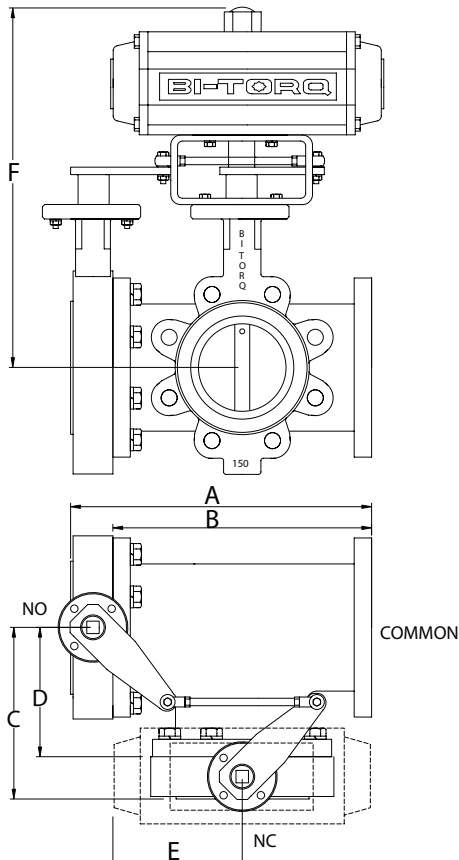

DOUBLE ACTING PNEUMATIC

VALVE SIZE	A	B	C	D	E	F	ACTUATOR
2"	10.69	9.00	6.19	4.50	3.19	10.30	PN-63-DA
2.5"	11.81	10.00	6.81	5.00	3.19	10.85	PN-63-DA
3"	12.81	11.00	7.31	5.50	4.08	14.74	PN-75-DA
4"	15.05	13.00	8.55	6.50	4.68	15.93	PN-85-DA
5"	17.20	15.00	9.70	7.50	5.35	16.96	PN-100-DA
6"	18.20	16.00	10.20	8.00	6.46	18.26	PN-115-DA
8"	20.36	18.00	11.36	9.00	8.43	20.96	PN-140-DA
10"	24.68	22.00	13.68	11.00	10.28	23.08	PN-160-DA
12"	27.07	24.00	15.07	12.00	11.32	26.86	PN-200-DA

SPRING RETURN PNEUMATIC

VALVE SIZE	A	B	C	D	E	F	ACTUATOR
2"	10.69	9.00	6.19	4.50	4.68	14.40	PN-85-SR
2.5"	11.81	10.00	6.81	5.00	5.35	15.46	PN-100-SR
3"	12.81	11.00	7.31	5.50	5.35	15.70	PN-100-SR
4"	15.05	13.00	8.55	6.50	6.46	17.23	PN-115-SR
5"	17.20	15.00	9.70	7.50	8.43	16.11	PN-140-SR
6"	18.20	16.00	10.20	8.00	8.43	19.62	PN-140-SR
8"	20.36	18.00	11.36	9.00	10.28	21.82	PN-160-SR
10"	24.68	22.00	13.68	11.00	11.32	23.83	PN-200-SR
12"	27.07	24.00	15.07	12.00	13.23	30.48	PN-270-SR