

MS-3WF SERIES FLANGED 3-WAY BALL VALVES

BILL OF MATERIALS

PART #	NAME	MATERIAL	QTY
1	END CAP	CF8M	3
2	BODY	CF8M	1
3	BALL AND STEM	316SS	1
4	BUSHING	TFE	1
5	BALL SEAT	RTFE THRU 2"; TFE 2-1/2" THRU 4"	4
6	BODY SEAL	TFE	4
7	O-RING	VITON	1
8	STEM PACKING	TFE	1
9	PACKING GLAND	304SS	1
10	BELLEVILLE WASHER	301SS	2
11	GLAND NUT	304SS	1
12	HANDLE NUT	304SS	1
13	STOP PIN	304SS	1
14	HANDLE BOLT	304SS	1
15	HANDLE	304SS	1
16	BLIND CAP	CF8M	1
17 - 19	BOLTS AND NUTS	304SS	8
20	BONNET	CF8M	1
21	GASKET	TFE	1

See page 31 for possible pressure limitations due to flow patterns in certain applications with our floating ball valve design.

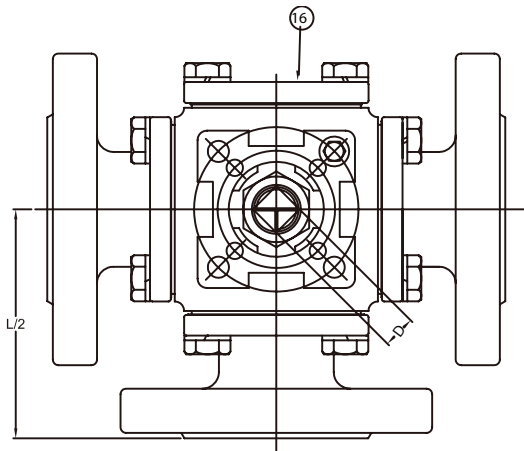

VALVE FEATURES

- 3-Way full port stainless steel valves
- 1/2" through 4" size range
- Ideal for mixing, food and chemical applications
- RTFE® seats through 2"; TFE 2-1/2" - 4"
- ANSI 150# Flanged
- 4-seat design for high cycle automation
- Self-adjusting stem packing w/belleville washers

NOTE: not suitable for vacuum service

PRESSURE RATING
ANSI Class 150
TEMPERATURE RATING
+450° F Maximum
-40° F Minimum

NOTE: MAXIMUM TEMPERATURE RATING FOR STANDARD ACTUATORS IS 150° F (ELECTRIC) AND 180° (PNEUMATIC). SPECIAL SEALS OR HEAT EXTENSIONS ARE AVAILABLE FOR HIGH TEMPERATURE SERVICE.

SEE PAGE 31 FOR AVAILABLE FLOW PATTERNS

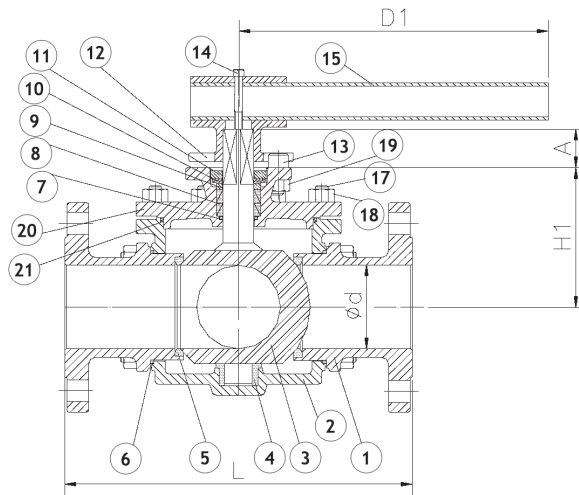

DIMENSIONAL DATA

SIZE	ISO 5211	d	L	L2	H1	A	D1	D	WT.
1/2"	F03-F04	0.59	5.98	2.99	1.65	0.43	5.12	0.35	8.00
3/4"	F04-F05	0.79	6.57	3.29	1.91	0.55	6.50	0.43	10.0
1"	F04-F05	0.98	7.48	3.74	2.19	0.55	6.50	0.43	15.0
1-1/4"	F05-F07	1.26	8.19	4.09	2.48	0.67	8.07	0.55	22.0
1-1/2"	F05-F07	1.50	8.66	4.33	2.89	0.63	8.07	0.55	29.0
2"	F07-F10	1.97	9.96	4.98	3.64	0.83	12.80	0.67	48.0
2-1/2"	F10	2.44	11.81	5.91	4.69	0.98	15.75	0.87	55.0
3"	F10	2.99	12.01	6.00	5.39	0.98	19.69	0.87	71.0
4"	F10	3.78	14.53	7.26	6.18	0.98	23.62	0.87	118

THE MANUAL VERSION OF THIS MODEL STARTS WITH AN "M"

ALL VALVES ARE 100% ELECTRONICALLY TESTED AT 80 PSI IN BOTH THE OPEN AND CLOSED POSITIONS